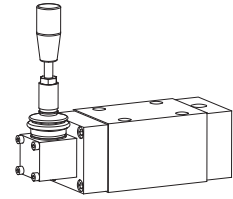

Spool valve
Hand- or roller operated

- 4/2- and 4/3-way detented
- 4/3-way with spring centred mid position
- 4/2-way with spring reset
- $Q_{\max} = 100 \text{ l/min}$, $p_{\max} = 350 \text{ bar}$

NG10
ISO 4401-05

DESCRIPTION

Spool valve NG10, flange type in accordance with ISO 4401-05 with 4 connections, directly operated by hand or roller, in 5 chamber system. The hand lever valve is available with locked spool or with spring reset. The dancing roller valve only has a spring reset facility. Precise spool fit, little leakage, long life. Threaded connection by means of additional connecting plate. Hardened steel spool, the valve body being made from a high quality casting suitable for hydraulic applications. The valve body is painted, the end cover and lever housing are phosphatised.

FUNCTION

When actuated, the lever or roller displaces the spool to the corresponding switching position.

- 4/2- and 4/3-way manual valves with spring, 1 lever and 2 or 3 switching positions. The spring presses the spool back into the home position.
- 4/2- and 4/3-way manual lever valve with lock, 1 lever and 2 or 3 switching positions. The lock holds the spool in the last position selected.
- 4/2-way dancing roller valve, 1 dancing roller and 2 switching positions. The spring presses the spool back to the starting position.

APPLICATION

Mechanically operated spool valves are mainly used to control the direction of movement and retain hydraulic cylinders and motors. The direction of movement is determined by the position of the valve spool and its symbol. Mechanically operated valves are particularly suitable for use in installations where no control current is available or for applications in areas where there is a risk of explosion (chemical industry, tunnel construction).

CONTENT

GENERAL SPECIFICATIONS.....	1
HYDRAULIC SPECIFICATIONS.....	1
HYDRAULIC SPECIFICATIONS.....	1
TYPE CHARTS/SYMBOLS.....	2
CHARACTERISTICS.....	2
DIMENSIONS.....	3
PARTSLIST.....	3
ACCESSORIES.....	3

TYPE CODE

International interface ISO	A	<input type="checkbox"/>	4	<input type="checkbox"/>	/	<input type="checkbox"/>	#	<input type="checkbox"/>
Operations:	Hand lever	<input type="checkbox"/>						
	Roller	<input type="checkbox"/>						
Number of control ports								
Description of symbols acc. to table	side-a	<input type="checkbox"/>						
1.5-50/2	side-b	<input type="checkbox"/>						
Spring return	<input type="checkbox"/>							
Detented	<input type="checkbox"/>							
	(only by hand lever operation)							
Design-Index (Subject to change)								

GENERAL SPECIFICATIONS

Description	4/2-, 4/3-way-valve
Nominal size	NG10 to ISO 4401-05
Construction	Direct operated spool valve
Operations	Hand operated (hand lever) or roller
Mounting	Flange
	4 fixing holes for socket head cap screws M6x65
Connections	Threaded connection plates
	Multi-flange plates, Manifolds
	Longitudinal stacking system
Ambient temperature	-20...50 °C
Mounting position	any, preferable horizontal
Fastening torque	$M_b = 9.5 \text{ Nm}$ (screw quality 8.8)
Weight:	$m = 3,4 \text{ kg}$

HYDRAULIC SPECIFICATIONS

Fluid	Mineral oil, other fluid on request
Contamination efficiency	ISO 4406:1999, class 20/18/14 (Required filtration grade $\beta_{10...16} \geq 75$) refer to data sheet 1.0-50/2
Viscosity range	12 mm ² /s...320 mm ² /s
Fluid temperature	-20...+70 °C
Operating pressure in port P, A, B	$p_{\max} = 350 \text{ bar}$
Tank pressure in port T	$p_{\max} = 100 \text{ bar}$
Max. volume flow	$Q_{\max} = 100 \text{ l/min}$ (see characteristics)
Leakage volume flow	see characteristics

CONTROL MECHANICAL

Angle (Hand lever)	$\alpha_b = 10,8^\circ/\text{Seite}$
Stroke (roller)	$S_b = 3,8 \text{ mm}$
Forcet:	
- Hand lever	$F_b = 16 - 30 \text{ N}$
- roller	$F_b = 100 - 180 \text{ N}$

TYPE LIST / DESIGNATION OF SYMBOLS

4/2-way valve with spring reset or detented

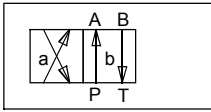

Z100a

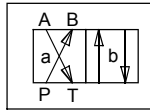

Z100b

Transitional functions

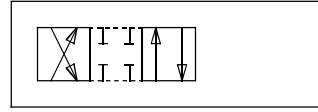

4/3-way valve spring centered or detented (only by hand lever operation)

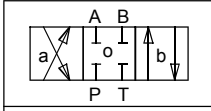
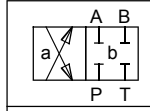
 D101a
D101b

Z101a

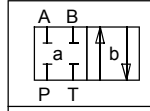

Z101b

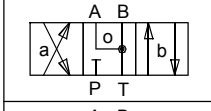
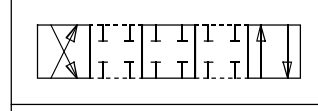
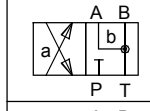
 D102a
D102b

Z102a

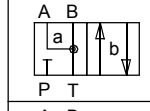

Z102b

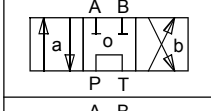
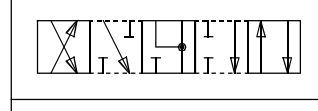
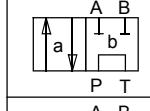
 D103a
D103b

Z103a

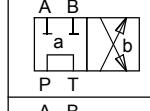

Z103b

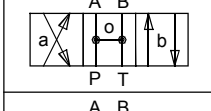
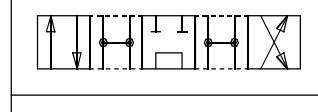
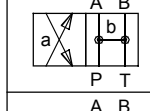
 D104a
D104b

Z104a

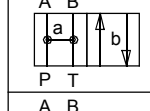

Z104b

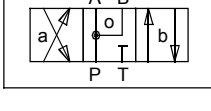
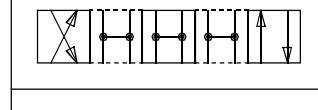
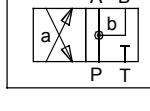
 D105a
D105b

Z105a

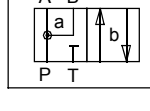

Z105b

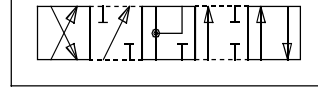
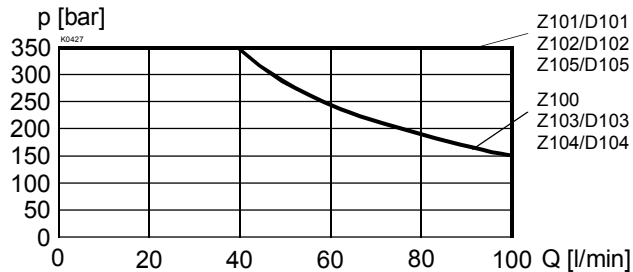
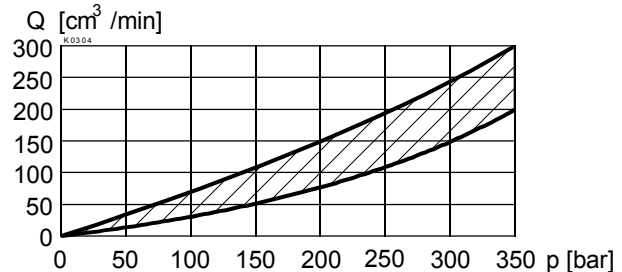
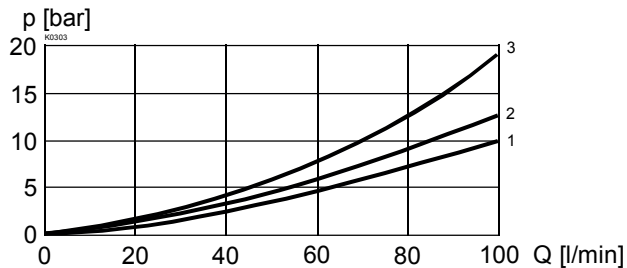
CHARACTERISTICS Oilviscosity $\nu = 30 \text{ mm}^2/\text{s}$
 $p = f(Q)$ Performance limits

 $Q_L = f(p)$ Leakage volume flow characteristics per control edge

 $\Delta p = f(Q)$ Pressure drop volume flow characteristics

Symbol	Pressure drop curve no.	Volume flow direction				
		P - A	P - B	P - T	A - T	B - T
Z100/J100	2	2	-	2	2	
D101/Z101	2	2	-	2	2	
D102/Z102	2	2	-	1	1	
D103/Z103	2	2	3	2	2	
D104/Z104	1	1	-	1	1	
D105/Z105	1	1	-	2	2	

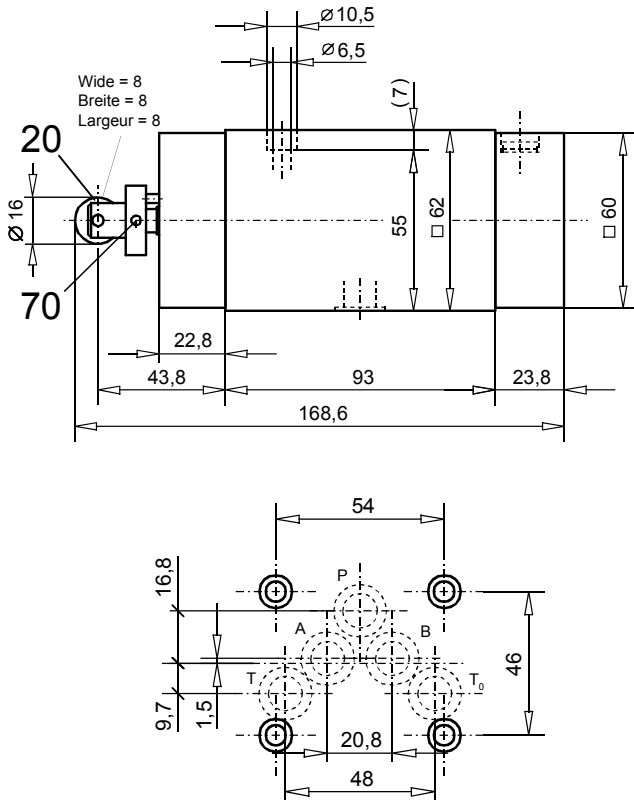
DIMENSIONS

Roller operated

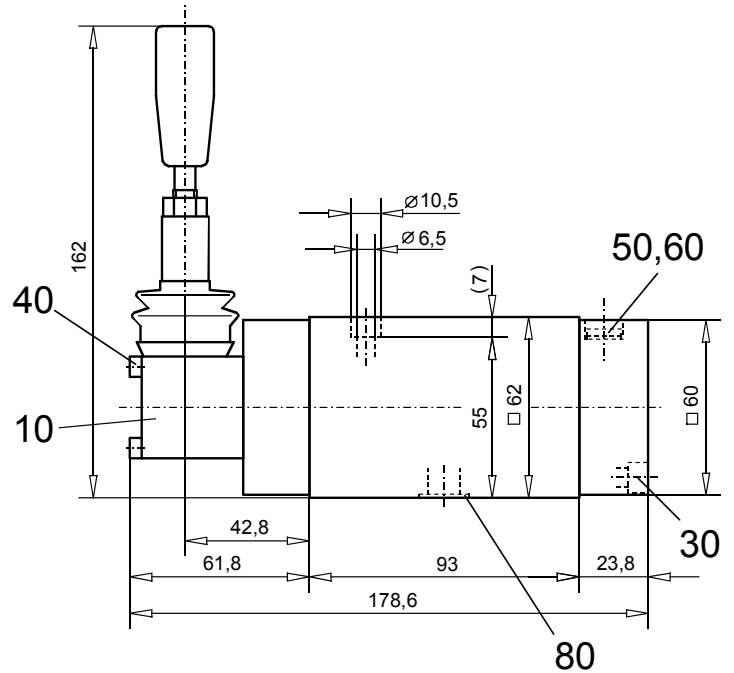

Hand operated

PARTS LIST

Position	Article	Description
10	253.2000	Hand control head BH II
20	253.4100	Mechanical control head AT II
30	246.3125	Socket head cap screw M6 x 25 DIN 912
40	246.1140	Socket head cap screw M4 x 40 DIN 912
50	238.0201	Plug screw M8 x 1 DIN 908 (by spring centred version)
	239.2000	Plug screw (by dedented version)
60	049.1080	Cop. seal ring NG 8 x 11,5 x 1 DIN 7603 (only by dedented version)
70	221.2271	Spring tension pin \varnothing 3 x 16 DIN 1481
80	160.2140	O-ring ID14,00 x 1,78

ACCESSORIES

Threaded connection plates, Multi-flange plates and longitudinal stacking system

register 2.9

Technical explanation see data sheet 1.0-100